

Repair Manual Supplement: Vehicle Pulling to One Side

Service Category Steering

Section Steering Gear/Linkage

Market USA

Lexus Supports
ASE Certification 

Applicability

YEAR(S)	MODEL(S)	ADDITIONAL INFORMATION
2002 – 2003	ES300, RX300	
2004 – 2006	ES330, RX330	
2007 – 2009	ES350, GS350, GS450H, LS460	
2002 – 2006	GS300, LS430	
2002 – 2007	GS430, LX470	
2008 – 2009	GS460, IS F, LS600H, LX570	
2003 – 2009	GX470	
2006 – 2009	IS250, IS350	
2002 – 2005	IS300	
2007 – 2009	RX350	
2006 – 2008	RX400H	
2002 – 2009	SC430	

TSIB SUPERSESSION NOTICE

The information contained in this TSIB supersedes the following TSIBs:

- **ST004-01:** Applicability has been updated to include 2008 – 2009 model year Lexus vehicles.
- **SU001-08:** Applicability has been updated to include all 2002 – 2009 model year vehicles.

TSIB Nos. ST004-01 and SU001-08 are Obsolete and any printed versions should be discarded. Be sure to review the entire content of this service bulletin before proceeding.

Repair Manual Supplement: Vehicle Pulling to One Side

Introduction

This bulletin contains general vehicle pulling diagnosis and repair procedures along with specific information to help correct pulling complaints.

This information supplements Repair Manual procedures when the symptoms are:

- The driver holds the steering wheel without exerting steering effort while driving straight ahead, the vehicle drifts to the right or the left.
- While driving straight ahead, the driver has to steer either to the right or the left to maintain straight driving.

Warranty Information

OP CODE	DESCRIPTION	TIME	OFF	T1	T2
044184	Preliminary Check & Road Test	0.6	45046-09020	31	99
Combo A	Switch Front Tire/Wheel & Road Test	0.5			
Combo B	Reverse the Front One Side Tire	0.7			
Combo C	Check Front Wheel Alignment	1.2			
Combo D	Adjust Front Wheel Alignment	0.7			
Combo E	Adjust Camber Setting	0.7			
420091	Dismount and Mount Tire and Balance Wheel and Tire Assembly	0.5	42611-08010		
Combo A	Each additional Wheel	0.3			

NOTE

OP Code 044184 and the above combination codes apply to all models with the EXCEPTION of Combo E for IS 250, IS 250 AWD, and IS 350 models.

APPLICABLE WARRANTY

- This repair is covered under the Lexus Comprehensive Warranty. This warranty is in effect for 12 months or 20,000 miles, whichever occurs first, from the vehicle's in-service date.
- Warranty application is limited to correction of a problem based upon a customer's specific complaint.

Repair Manual Supplement: Vehicle Pulling to One Side

Contents

This bulletin is divided into the following sections:

- Wheel Alignment and Tire Characteristics
- Repair Procedure Flow Chart
- Repair Procedure
 - Important Notice
 - Troubleshooting
 - Vehicle Pulling Caused by Wheel Alignment
 - Vehicle Pulling Caused by Tire Conicity
 - Camber Adjustment Method

Wheel Alignment & Tire Characteristics

1. Relationship Between Wheel Alignment and Vehicle Pulling to One Side

When the cross camber or caster of the front wheel alignment is large, it can cause vehicle pulling.

WHEEL ALIGNMENT	DIRECTION OF VEHICLE PULLING
Camber	Vehicle Pulls in Direction of Wheel with Large Camber Value (See Figure 1)
Caster	Vehicle Pulls in Direction of Wheel with Small Caster Value (See Figure 2)

Figure 1. Camber

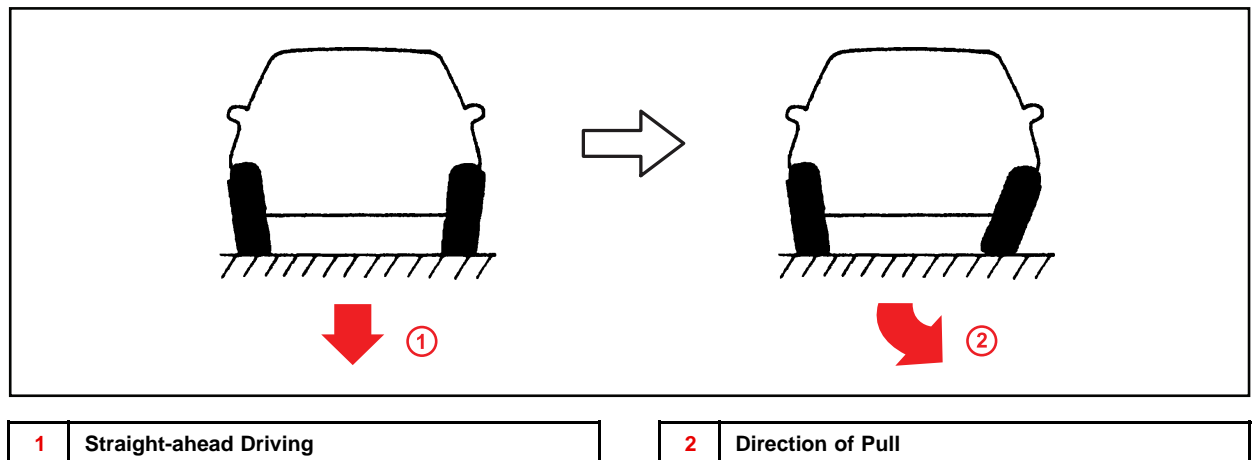

Repair Manual Supplement: Vehicle Pulling to One Side

Wheel Alignment & Tire Characteristics (Continued)

Figure 2. Caster

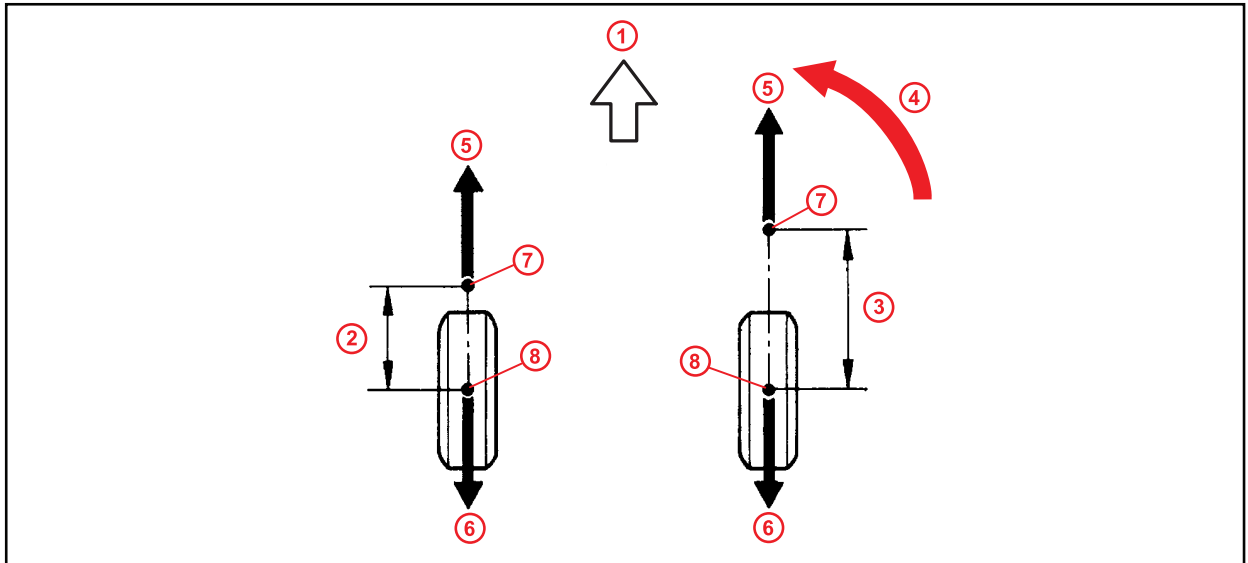

1	Front
2	Caster Trail (Small)
3	Caster Trail (Large)
4	Direction of Pull

5	Driving Force
6	Reactive Force
7	Steering Axis
8	Center of Tire – Road Contact Area

If the cross camber or caster is within the specified range (30' or less), noticeable vehicle pulling will not occur due to side-to-side differences in camber or caster.

NOTE

On a flat road, if the cross camber or caster is 30' or less and the steering wheel is held without exerting steering effort for 109 yards (100 m) when driving at 62 mph (100 km/h), the alignment-induced drift distance is approximately 1.64 feet (0.5 m).

Repair Manual Supplement: Vehicle Pulling to One Side

Wheel Alignment & Tire Characteristics (Continued)

2. Relationship Between Tire Characteristics and Vehicle Pulling to One Side

When radial tires are rotating, they have the characteristic of generating force in the lateral direction between the tire and the road surface. This lateral force is comprised of two factors:

- Ply-steer, which changes direction according to the rotation direction of the tires.
- Conicity, which is generated in a fixed direction regardless of the tire rotation direction.

If these lateral forces are too strong, vehicle pulling will occur.

A. Ply-Steer

Lateral force due to ply-steer is produced by the construction of the belts inside the tire tread. With radial tires, the wire of the belt is slanted as shown in the illustration below. Thus, it is in the lateral direction that tire tread easily changes shape (stretches), and lateral force is generated between the tire and the road surface in the lateral direction.

Figure 3.

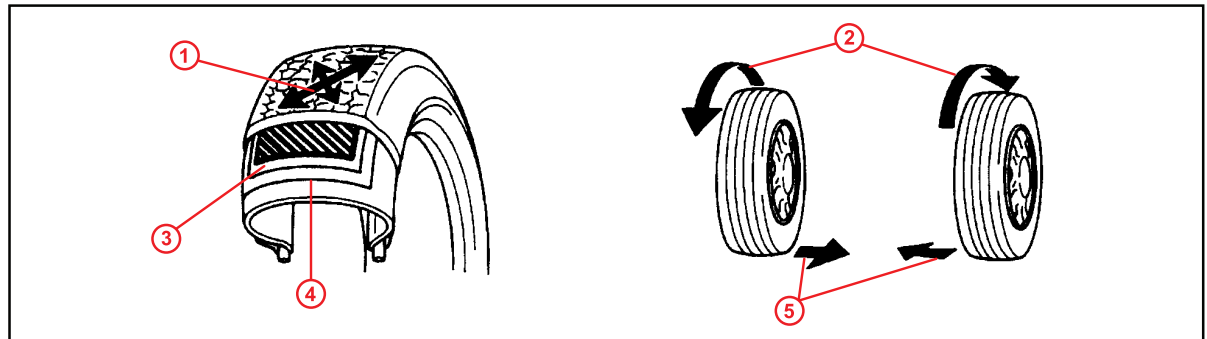

1	Easily Stretched Direction
2	Rotation Direction
3	Wire

4	Belt
5	Ply-Steer (Direction of Force Generation Varies According to Tire Rotation)

NOTE

Lateral force from ply-steer prevents vehicle drift caused by road slant, so in many cases lateral force to the left is provided to compensate for road slant to the right.

Repair Manual Supplement: Vehicle Pulling to One Side

Wheel Alignment & Tire Characteristics (Continued)

B. Conicity

Conicity is lateral force resulting from uneven formation of the left and right sides of the tire. The direction the lateral force is exerted depends on the hardness of the side walls and the difference in height between the left/right sides of the tire.

NOTE

- In the case of vehicle pulling caused by tires, the lateral force which is exerted as a result of conicity has the greatest effect. On a flat road, if the steering wheel is held without exerting steering effort for 109 yards (100 m) when traveling at 62 mph (100 km/h), the vehicle may drift as much as 5 feet (1.5 m).
- When vehicle pulling is due to conicity, the amount of drift can be reduced and the direction of drift can be changed by changing the location of the tire or reversing the tire when installing it on the wheel.

Figure 4.

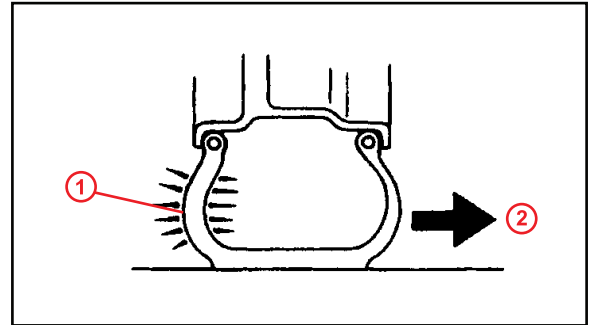

1	Hard Part
2	Conicity (Direction is Fixed Regardless of Direction of Tire Rotation)

Repair Manual Supplement: Vehicle Pulling to One Side

Repair Procedure Flow Chart

Figure 5.

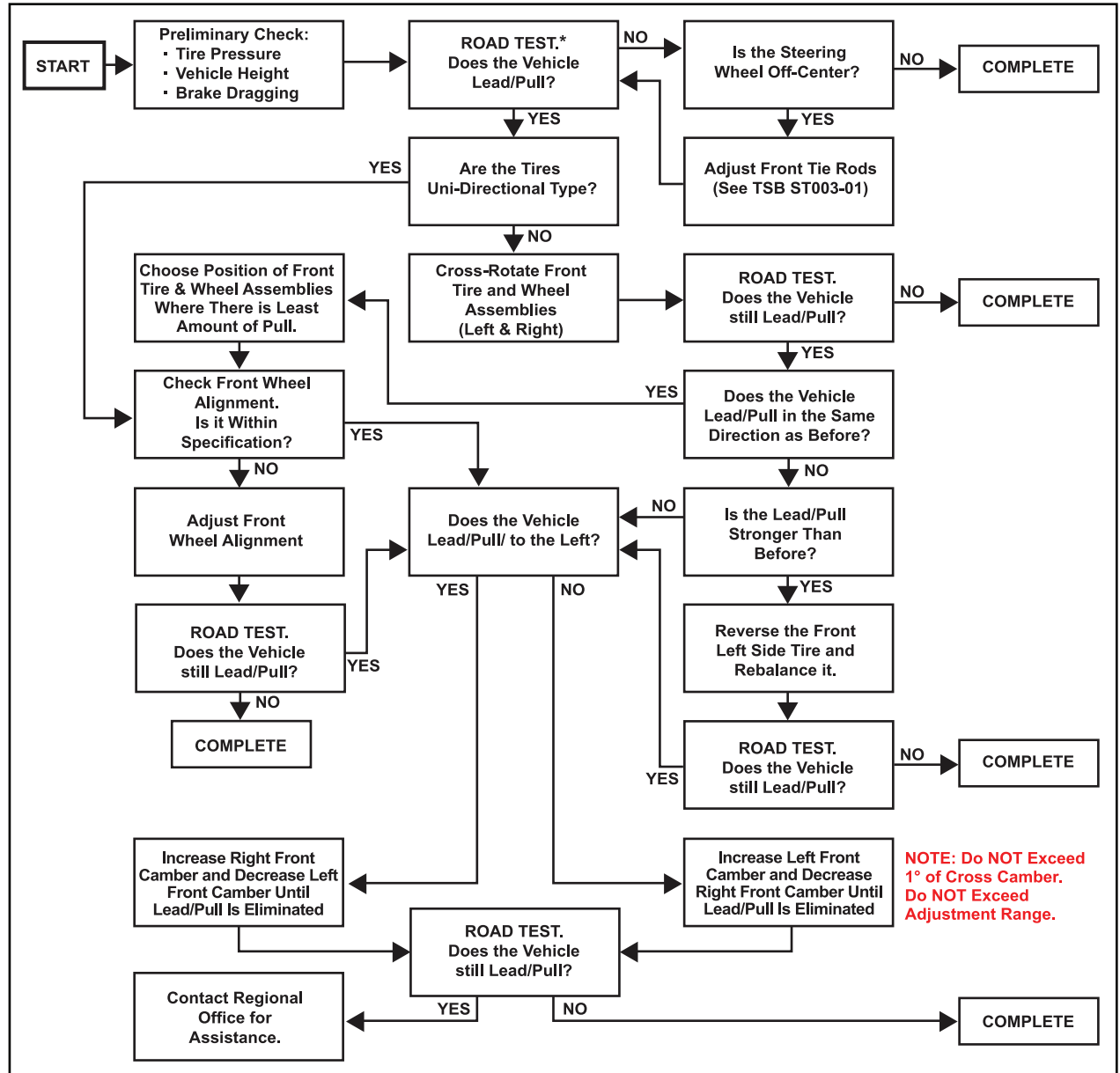

NOTE: Do NOT Exceed 1° of Cross Camber. Do NOT Exceed Adjustment Range.

* Select a flat road where the vehicle can be driven in a straight line for 109 yards (100 meters) at a constant speed of 35 mph (56 km/h). Please confirm safety and set the steering wheel to its straight position. Drive the vehicle in a straight line for 109 yards (100 meters) at a constant speed of 35 mph (56 km/h) without exerting steering effort on the steering wheel.

- **Steering Off Center:** The vehicle goes straight but the steering wheel has some angle.
- **Steering Pull:** The vehicle does NOT go straight.

Repair Manual Supplement: Vehicle Pulling to One Side

Repair Procedure

IMPORTANT NOTICE

Before repairing vehicle pulling to one side, it is necessary to clearly identify the cause of the pulling condition. Frequently, the cause of the vehicle pulling to one side is diagnosed as wheel alignment. However, the actual cause may be lateral force generated by the tires. Performing wheel alignment when tire force is the cause could result in the wheel alignment being set at a value outside of specifications. This would then cause other problems such as uneven tire wear, etc.

1. Troubleshooting

First determine whether vehicle pulling to one side is caused by a wheel alignment problem or tire characteristics, then decide which repairs to make.

A. Perform the following checks and correct as necessary.

- (1) Check tires for size, wear and for proper inflation pressure.
- (2) Check whether the vehicle is noticeably tilted backward/forward or left/right.

NOTE

Tilting of the vehicle produces a left-right difference in the camber and caster and can cause vehicle pulling to one side.

- (3) Check brakes for dragging.

B. Confirm problem symptoms.

With the customer accompanying you, drive the vehicle to confirm if the customer's complaint involves vehicle pulling to one side or steering wheel off center.

If the problem is steering wheel off center, refer to the Repair Manual for the adjustment procedure. For 2002 model year vehicles only, refer to TSIB No. [ST002-01](#), "Steering Wheel Off Center Adjustment Procedure". Also check the direction of vehicle pulling and the extent of the pulling.

C. Decide if vehicle pulling is due to wheel alignment or tires.

- (1) Switch the left and right front tires (If the tires are non-unidirectional).
- (2) Conduct a drive test to check whether the direction that the vehicle pulls has changed.

SYMPTOM	PROBABLE CAUSE	CORRECTIVE ACTION
No Change in Vehicle Pulling Condition	Front Wheel Alignment	Proceed to Repair Procedure Step 2. Vehicle Pulling Caused by Wheel Alignment
Vehicle Pulling Eliminated	Tire Conicity	Repair Complete. Vehicle Pulling Caused by Tire Conicity
Vehicle Pulling Direction Is Reversed	Tire Conicity	Proceed to Repair Procedure Step 3. Vehicle Pulling Caused by Tire Conicity

Repair Manual Supplement: Vehicle Pulling to One Side

Repair Procedure (Continued)

Helpful hints to determine cause of vehicle pulling:

- The direction of lateral force from tire conicity becomes reversed when the left and right tires are switched. Therefore, if the pulling direction changes when the tires are switched, it can be concluded that vehicle pulling is caused by tire conicity.

- The vehicle is pulled to the right by the lateral force exerted to the right.

Figure 6. Original Tire Positions

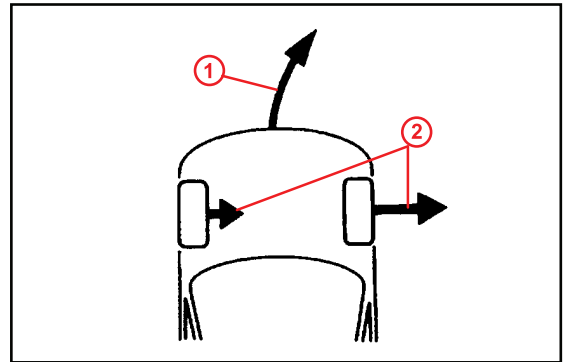

1	Vehicle Pulling Direction (Right)
2	Lateral Force by Conicity

- The direction of the tires which exerted lateral force to the right has been changed, so the tires now exert lateral force to the left and the vehicle now pulls to the left.

Figure 7. Tires Switched

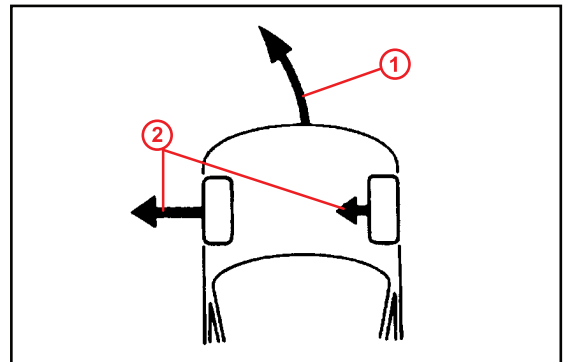

1	Vehicle Pulling Direction (Left)
2	Lateral Force by Conicity

- If the pulling direction does not change after the front tires are switched, the cause of vehicle pulling is not tire conicity. In this case, the likely cause is a front wheel alignment condition.

Repair Manual Supplement: Vehicle Pulling to One Side

Repair Procedure (Continued)

2. Vehicle Pulling Caused by Wheel Alignment.

When it is determined by troubleshooting that the vehicle pulling to one side is caused by wheel alignment, perform repairs according to the following procedure.

Figure 8.

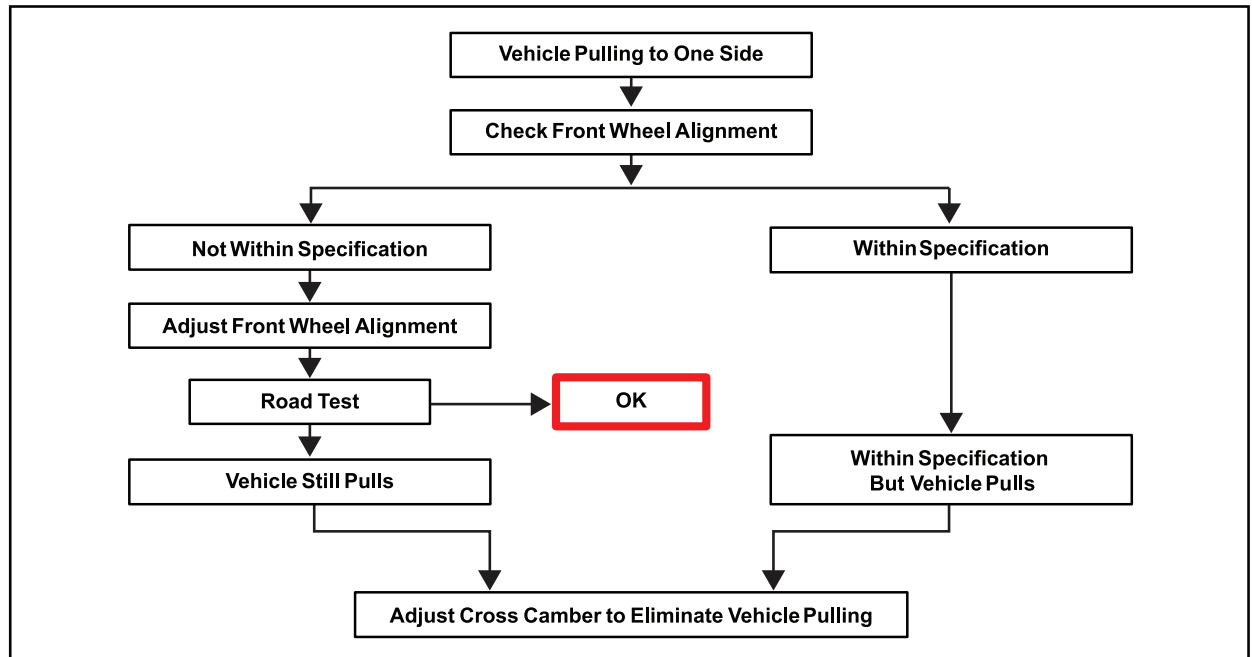

WHEN VEHICLE PULLS TO LEFT	WHEN VEHICLE PULLS TO RIGHT
Increase right front camber and decrease left front camber until vehicle pulling is eliminated	Increase left front camber and decrease right front camber until vehicle pulling is eliminated

NOTE

- Keep the cross camber within 1° or less.
- Keep the camber of each wheel within specifications (+/-45' of center value).
- If adjustment exceeds the specifications, uneven tire wear will result.

Repair Manual Supplement: Vehicle Pulling to One Side

Repair Procedure (Continued)

3. Vehicle Pulling Caused by Tire Conicity.

When it is determined by troubleshooting that the vehicle pulling to one side is caused by tire conicity, perform repairs according to the following procedures.

Indication of Tire Conicity as a Cause:
When the front tires are switched, the pulling direction changes. Proceed to step 3A below.

- A. Remove the front left tire from the wheel and reverse the tire. Then perform a road test and check for change in the pulling direction.

HINT
By performing this operation, it can be checked whether the left or right tire exerts a stronger lateral force. Either tire can be reversed. Shown here is an example of the left tire reversed.

If Vehicle Pulls in the Same Direction: Go to step 3B.

The lateral force generated by the right front tire is greater than the left tire, so the vehicle is pulling due to the lateral force of the right tire.

Figure 9. Original Tire Positions

Figure 10. Left Tire Reverse Installation

1	Vehicle Pulling Direction	1	Vehicle Pulling Direction (Same Direction)
2	Lateral Force by Conicity (Smaller)	2	Reversed
3	Lateral Force by Conicity (Larger)	3	Lateral Force by Conicity (Smaller)
		4	Lateral Force by Conicity (Larger)

Repair Manual Supplement: Vehicle Pulling to One Side

Repair Procedure (Continued)

If Vehicle Pulls in the Opposite Direction: Go to step 3B.

The lateral force generated by the left front tire is greater than the right tire, so the vehicle is pulling due to the lateral force of the left tire.

Figure 11. Original Tire Positions

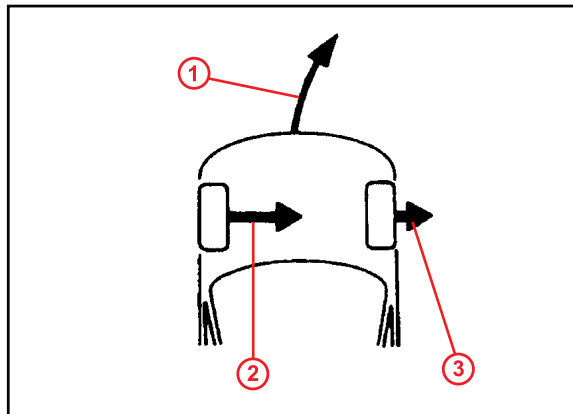

1	Vehicle Pulling Direction
2	Lateral Force by Conicity (Larger)
3	Lateral Force by Conicity (Smaller)

Figure 12. Left Tire Reverse Installation

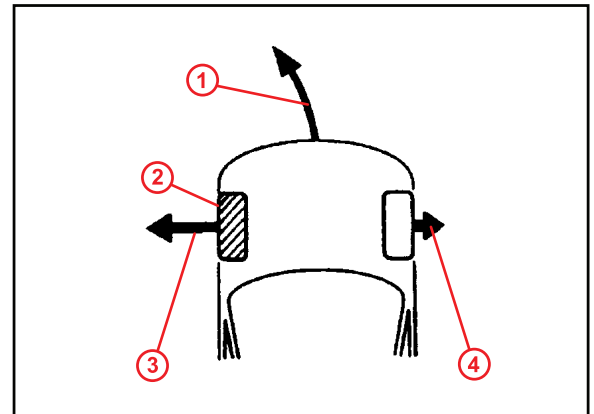

1	Vehicle Pulling Direction (Opposite Direction)
2	Reversed
3	Lateral Force by Conicity (Larger)
4	Lateral Force by Conicity (Smaller)

If Vehicle Pull Is Eliminated: Repair Is Now Complete.

The lateral force generated by the left and right front tires is virtually the same, so the lateral force is neutralized and the vehicle travels straight ahead. The repair operation is now completed.

- B. Rotate the **larger** lateral force front tire with the rear tire and check the change in the vehicle pulling.

NOTE

By shifting the front tire with the larger lateral force to the rear, the vehicle pulling level is usually reduced.

If Vehicle Is Still Pulling: Go to step 3C.

If Vehicle Pull Is Eliminated: Repair Is Now Complete.

Repair Manual Supplement: Vehicle Pulling to One Side

Repair Procedure (Continued)

C. Adjust cross camber to eliminate vehicle pulling.

HINT

If the tires are placed in the positions they were in during tire rotation when the least amount of vehicle pulling occurred, wheel alignment can be performed with a minimal amount of adjustment.

WHEN VEHICLE PULLS TO LEFT	WHEN VEHICLE PULLS TO RIGHT
Increase right front camber and decrease left front camber until vehicle pulling is eliminated	Increase left front camber and decrease right front camber until vehicle pulling is eliminated

NOTE

- Keep the cross camber within 1° or less.
- Keep the camber of each wheel within specifications (+/-45' of center value).
- If adjustment exceeds the specifications, uneven tire wear will result.

4. Camber Adjustment Method.

NOTE

- After the camber has been adjusted, inspect the toe-in.
- The method of camber adjustment differs for different models, so please refer to the Repair Manual of the vehicle involved. (The information below are samples from the RX 300 Repair Manual.)

A. Remove the front wheels and ABS speed sensor clamp.

Figure 13.

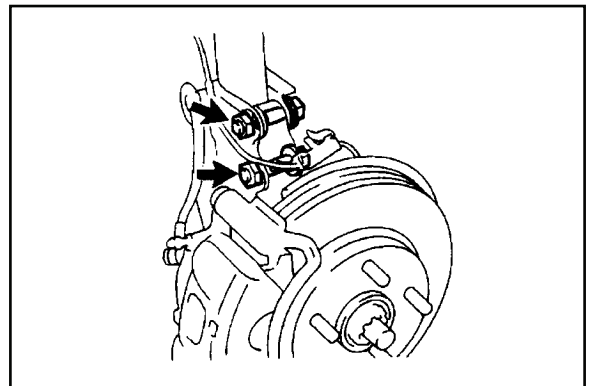

Repair Manual Supplement: Vehicle Pulling to One Side

Repair Procedure (Continued)

- B. Remove the two nuts on the lower side of the shock absorber.

Figure 14.

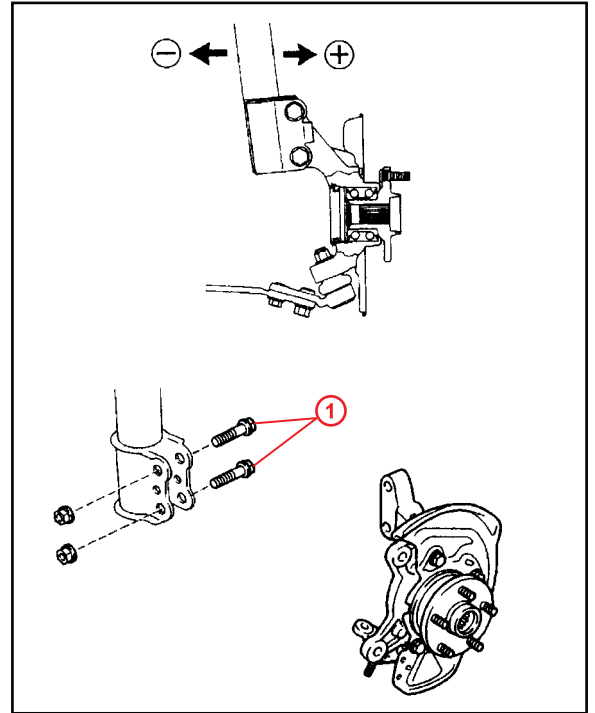

1	Nuts
----------	-------------

- C. Coat the threads of the nuts with engine oil.
- D. Temporarily install the two nuts.
- E. Adjust the camber by pushing or pulling the lower side of the shock absorber in the direction in which the camber adjustment is required.
- F. Tighten the nuts.
Torque: 210 N*m (2150 kgf*cm, 155 ft*lbf)
- G. Install the front wheels.
Torque: 104 N*m (1050 kgf*cm, 77 ft*lbf)

Repair Manual Supplement: Vehicle Pulling to One Side

Repair Procedure (Continued)

H. Check the camber.

NOTE

Adjusting value for the set bolts is 6' – 30' (0.1° – 0.5°). When making an adjustment of more than 45', replace the upper and lower steering knuckle set bolts with the adjusting bolts. If the camber is NOT within the specification, use the table shown to estimate how much additional camber adjustment will be required, and select the appropriate camber adjusting bolt.

ADJUSTING VALUE	SET BOLT		ADJUSTING BOLT						
			1 DOT		2 DOTS		3 DOTS		
	1	2	1	2	1	2	1	2	
15'	X			X					
30'	X					X			
45'	X								X
1°00'			X						X
1°15'					X				X
1°30'							X	X	

I. Follow steps 4A through 4H again. Between steps 4B and 4C, exchange one or two selected bolts.

HINT

When exchanging the two bolts, exchange one bolt at a time.

If Vehicle Pull Is Eliminated: Repair Is Now Complete.